



# INTERIOR COLLECTION

[www.trimlite.com](http://www.trimlite.com)

## OUR STORY

For over 30 years, Trimlite has been committed to producing high quality interior and exterior door and glass products. Founded in Vancouver, British Columbia, we operate manufacturing facilities in four countries with distribution locations across North America. Managing the largest interior wood door manufacturing facility in Western Canada, our team creates beautiful doors to meet your specific requirements.

Our Interior Door Collection is focused on the simple premise of crafting doors for the design needs of our diverse customers. It has something for every architectural space and style.

At Trimlite, Handcrafted Construction meets Modern Design.



**Interior Door Introduction and Design Ideas** ..... 4-9

**Quick Ship Shaker Doors & Bi-Folds** | Primed ..... 10-11

**Quick Ship Shaker Doors & Bi-Folds** | Knotty Alder & Fir ..... 12

**Quick Ship Applied Bead Doors** | Primed ..... 13

**Quick Ship Plantation Louver Doors & Bi-Folds** | Primed ..... 14

**Quick Ship Rustic & Shaker Barn Doors & Hardware** ..... 15-17

**Quick Ship French Doors** ..... 18-23

**Quick Ship Retro French Doors** ..... 24-25

**Custom Doors Introduction** ..... 26

**Custom Shaker Doors & Bi-Folds** | Primed ..... 27

**Custom Contemporary Doors w/Glass** | Primed ..... 28

**Custom Contemporary Doors w/Panels** | Primed ..... 29

**Custom Shaker Doors & Bi-Folds w/Glass** | Primed ..... 30

**Custom Shaker Doors & Bi-Folds** | Fir ..... 31

**Custom Contemporary Doors w/Panels** | Fir ..... 32

**Custom Contemporary Doors w/Glass** | Fir ..... 33

**Custom Shaker Doors & Bi-Folds** | Knotty Alder ..... 34

**Custom Oversized Shaker Barn Doors** ..... 35

**Custom Contemporary Barn Doors w/Glass** ..... 36

**Custom Flat Panel Ovolo Bead Doors** | Primed ..... 37

**Custom Raised Panel Doors** | Primed ..... 38

**Custom High Definition Doors** | Primed ..... 39

**Custom Woodbar French Doors** | Primed ..... 40-41

**Interior Door Components** ..... 42

**20-Minute Door Hanging Options** ..... 43

**Quick Ship Stocking Sizes** ..... 44-45

**Trimlite Warranty** ..... 46

## PRIVACY GUIDE

Trimlite offers an extensive line of glass options to choose from and the degree of opacity varies considerably. With each design, we have included a number which represents the “Privacy Level” for that product. Please refer to the guide below. Note: This guide is subjective. It should only be used when comparing Trimlite designs.

|                |                                                                       |   |   |                                                                          |   |   |                                                        |   |   |    |
|----------------|-----------------------------------------------------------------------|---|---|--------------------------------------------------------------------------|---|---|--------------------------------------------------------|---|---|----|
| <b>PRIVACY</b> | 1                                                                     | 2 | 3 | 4                                                                        | 5 | 6 | 7                                                      | 8 | 9 | 10 |
|                | <b>Completely Clear</b>                                               |   |   | <b>Diffused/Distorted</b>                                                |   |   | <b>Completely Opaque</b>                               |   |   |    |
|                | Objects can be clearly seen through the glass from the opposite side. |   |   | Objects are distorted, but can still be detected from the opposite side. |   |   | Only light will travel through from the opposite side. |   |   |    |



# INTERIOR DOOR INTRODUCTION

## LOCAL PRODUCTS

We source our wood products locally, selecting from high grades of Douglas Fir, Knotty Alder, and Pine. We believe our forests grow the best trees, and we want our doors to reflect that.

## FROM TREE TO HOME

Trimlite manufactures its door products both locally and globally, allowing us to control the quality of our products from tree to door.

## DETAILS MATTER

We pride ourselves on being manufacturers, and to us, the little details matter. Whether it is a perfect joint, a seam-free door, or a shaker with perfect edges, we want to build the best door, every time.



2'8" x 6'8"  
Primed OV55



MODERN FARMHOUSE

A balanced blend of modern and rustic, the Modern Farmhouse style continues to be a rising trend. We paired some of our favorite doors and hinge options that intelligently mix modern and traditional.



Primed 8401  
1-Panel Shaker



US1D  
Hinge



Knotty  
Alder  
8401BZ  
Z-Bar  
Barn  
Door



Primed 8433  
3-Equal Panel Shaker



US1D  
Hinge



Primed 8433  
White Lami Glass

Primed  
8933  
3-Lite  
Barn Door  
with Clear  
Glass



Primed 8730  
Plantation Louver



US1D  
Hinge



Primed 8401  
White Lami Glass



Primed  
8401B  
Barn  
Door



CONTEMPORARY

Contemporary homes reflect the architecture and design of today. They represent smart design and curb appeal. We selected several doors that we believe represent the ethos of now and can be loved forever.



Primed 8433  
3-Equal Panel Shaker



Primed  
8401  
BFWR  
Barn  
Door



US1D  
Hinge



Primed 8444  
4-Panel Shaker



Primed 8433  
White Lami Glass



US1D  
Hinge



Primed  
8966  
Contemporary  
Door with  
Clear Glass



Primed 8491  
2-Step Shaker



Primed 8601  
Satin Etch Glass



US1D  
Hinge



Knotty  
Alder  
8401BZ  
Z-Bar  
Barn  
Door



CRAFTSMAN











Craftsman homes emphasize hand-worked touches and beautiful detailing. Popularized at the turn of the 20th Century, it remains a popular design aesthetic. We have recommended several door and hardware options that give your doors the beautiful detailing a craftsman home requires.

|                                                                                                                                                                                                                                                                                                                                                                                                                                                                                                   |                                                                                                                                                                                                                                                                                                                                                                                                                                                                                                                |                                                                                                                                                                                                                                                                                                                                                                                                                                                                                                                                         |
|---------------------------------------------------------------------------------------------------------------------------------------------------------------------------------------------------------------------------------------------------------------------------------------------------------------------------------------------------------------------------------------------------------------------------------------------------------------------------------------------------|----------------------------------------------------------------------------------------------------------------------------------------------------------------------------------------------------------------------------------------------------------------------------------------------------------------------------------------------------------------------------------------------------------------------------------------------------------------------------------------------------------------|-----------------------------------------------------------------------------------------------------------------------------------------------------------------------------------------------------------------------------------------------------------------------------------------------------------------------------------------------------------------------------------------------------------------------------------------------------------------------------------------------------------------------------------------|
|  <p>Primed 8402<br/>2-Panel Shaker</p>  <p>Fir 8403<br/>3-Panel Shaker</p>  <p>Fir<br/>8401BZ<br/>Z-Bar<br/>Barn<br/>Door</p>  <p>US10B<br/>Hinge</p> |  <p>Knotty Alder 8403<br/>3-Panel Shaker</p>  <p>Primed 8403<br/>HD Door</p>  <p>Knotty<br/>Alder<br/>8402<br/>K-Bar<br/>Barn<br/>Door</p>  <p>US10B<br/>Hinge</p> |  <p>Fir 8405<br/>5-Panel Shaker</p>  <p>Fir 1501<br/>Clear Glass<br/>French Door</p>  <p>Primed<br/>8944<br/>Barn<br/>Door<br/>With<br/>Clear<br/>Glass</p>  <p>US10B<br/>Hinge</p> |
|---------------------------------------------------------------------------------------------------------------------------------------------------------------------------------------------------------------------------------------------------------------------------------------------------------------------------------------------------------------------------------------------------------------------------------------------------------------------------------------------------|----------------------------------------------------------------------------------------------------------------------------------------------------------------------------------------------------------------------------------------------------------------------------------------------------------------------------------------------------------------------------------------------------------------------------------------------------------------------------------------------------------------|-----------------------------------------------------------------------------------------------------------------------------------------------------------------------------------------------------------------------------------------------------------------------------------------------------------------------------------------------------------------------------------------------------------------------------------------------------------------------------------------------------------------------------------------|

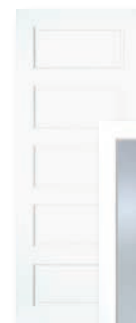

TRADITIONAL

Traditional homes are comforting and classic. Their interiors are calm, orderly and predictable. Everything matches and is consistent. We suggest these doors for completing the look in a traditional home style and décor.

|                                                                                                                                                                                                                                                                                                                                                                                                                                                                                                                      |                                                                                                                                                                                                                                                                                                                                                                                                                                                                                                               |                                                                                                                                                                                                                                                                                                                                                                                                                                                                                                                                                                    |
|----------------------------------------------------------------------------------------------------------------------------------------------------------------------------------------------------------------------------------------------------------------------------------------------------------------------------------------------------------------------------------------------------------------------------------------------------------------------------------------------------------------------|---------------------------------------------------------------------------------------------------------------------------------------------------------------------------------------------------------------------------------------------------------------------------------------------------------------------------------------------------------------------------------------------------------------------------------------------------------------------------------------------------------------|--------------------------------------------------------------------------------------------------------------------------------------------------------------------------------------------------------------------------------------------------------------------------------------------------------------------------------------------------------------------------------------------------------------------------------------------------------------------------------------------------------------------------------------------------------------------|
|  <p>Primed 8402<br/>2-Panel Shaker</p>  <p>Primed 8402BF<br/>2-Panel Shaker<br/>Bi-Fold</p>  <p>Primed<br/>1501<br/>Pantry<br/>French<br/>Door</p>  <p>US3<br/>Hinge</p> |  <p>Primed 8405<br/>Applied Ovolo Bead</p>  <p>Primed 8405<br/>5-Panel Shaker</p>  <p>Primed<br/>3501<br/>Adelaide<br/>French<br/>Door</p>  <p>US15<br/>Hinge</p> |  <p>Primed OV55<br/>Double Hip Raised Panel</p>  <p>Primed 1501<br/>Clear Glass<br/>French Door</p>  <p>Primed<br/>1310<br/>Woodbar<br/>French<br/>Door<br/>With<br/>Clear<br/>Glass</p>  <p>US3<br/>Hinge</p> |
|----------------------------------------------------------------------------------------------------------------------------------------------------------------------------------------------------------------------------------------------------------------------------------------------------------------------------------------------------------------------------------------------------------------------------------------------------------------------------------------------------------------------|---------------------------------------------------------------------------------------------------------------------------------------------------------------------------------------------------------------------------------------------------------------------------------------------------------------------------------------------------------------------------------------------------------------------------------------------------------------------------------------------------------------|--------------------------------------------------------------------------------------------------------------------------------------------------------------------------------------------------------------------------------------------------------------------------------------------------------------------------------------------------------------------------------------------------------------------------------------------------------------------------------------------------------------------------------------------------------------------|



Our Quick Ship program allows you to select beautifully designed doors when you need them. We stock an unrivaled selection of French and Shaker doors that will complement any home style. Let Trimlite™ help you create an interior look that will be a true reflection of your taste.

28" x 6'8"  
Primed 8020

Shaker Panel Doors

6/8  
1-3/8"  
Quick Ship\* Sizes:  
1/6, 1/8, 1/10, 2/0,  
2/2, 2/4, 2/6, 2/8,  
2/10, & 3/0



8401      8402      8403<sup>†</sup>      8433      8444      8405      8491

†: #8403 door in sizes 1/6 will have two panels. 🔥 Available as 20-Minute Fire Door. Call for sizes and availability.

Shaker French Doors: Diffused White Laminate (DWL)

6/8  
1-3/8"  
Quick Ship\* Sizes:  
2/0, 2/2,  
2/4, 2/6, 2/8,  
2/10, & 3/0



8401      8433      8405

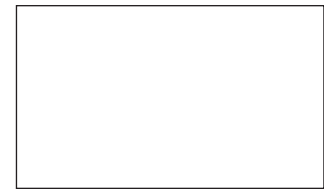

White Laminated  
Safety Glass  
PRIVACY 10

Shaker Bi-Folds (includes track & hardware)

6/7  
1-3/8"  
Quick Ship\* Sizes:  
2/0, 2/6, & 3/0



8401BF      8402BF      8403BF  
8433BF      8444BF      8405BF



\*Quick Ship: We make every effort to ensure all Quick Ship Items are in stock. However, we do not guarantee stock.

### Shaker Panel Doors

7/0  
1-3/8"  
Quick Ship \* Sizes:  
2/0, 2/2,  
2/4, 2/6, 2/8,  
2/10, & 3/0

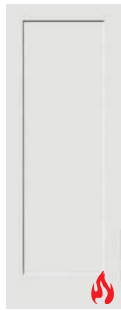

8401



8402



8433



8405

Available as  
20-Minute  
Fire Door.  
Call for  
sizes and  
availability.

### Shaker Panel Doors

8/0  
1-3/8"  
Quick Ship \* Sizes:  
1/6, 2/0, 2/2,  
2/4, 2/6, 2/8,  
2/10, & 3/0



8401



8402



8403†



8433



8405



8491

†: #8403 door in sizes 1/6 will have two panels.

### Woodbar French Doors

6/8  
1-3/8"  
Quick Ship \* Sizes:  
2/0, 2/2,  
2/4, 2/6,  
2/8 & 3/0



1309



1310

Not Available in 2/0 and 2/2.

\*1310 also  
available in 8/0.  
The 8/0 version  
will have 12 lites.

### Flat Panel Ovolo Doors & Bifolds (includes track & hardware)

6/8  
1-3/8"  
Quick Ship \*  
Sizes: 1/6, 2/0,  
2/2, 2/4, 2/6,  
2/8, 2/10, & 3/0



8020



8082



8020BF



8082BF



3'0" x 6'8"  
Primed 8444

\*Quick Ship: We make every effort to ensure all Quick Ship Items are in stock. However, we do not guarantee stock.

# QUICK SHIP SHAKER | Knotty Alder & Fir

## Knotty Alder Doors

6/8  
1-3/8"

Quick Ship\* Sizes:  
1/6, 2/0, 2/2,  
2/4, 2/6, 2/8,  
2/10, & 3/0



8401



8402



8403†



2'6" x 6'8"  
Fir 8405

## Knotty Alder Bi-Folds (includes track & hardware)

6/7  
1-3/8"

Quick Ship\* Sizes:  
2/0, 2/6, & 3/0



8401BF



8402BF



8403BF

## Fir Doors

6/8  
1-3/8"

Quick Ship\* Sizes:  
1/6, 2/0, 2/2,  
2/4, 2/6, 2/8,  
2/10, & 3/0



8401



8402



8403†



8433



8405

†: #8403 door in sizes 1/6 will have two panels.

## Fir Bi-Folds: (includes track & hardware)

6/7  
1-3/8"

Quick Ship\* Sizes:  
2/0, 2/6, & 3/0



8401BF



8402BF



8403BF



8433BF



8405BF

†: #8403 door in sizes 1/6 will have two panels.

\*Quick Ship: We make every effort to ensure all Quick Ship Items are in stock. However, we do not guarantee stock.

Our beading options can give any shaker door a different appearance. Flexibility in architectural styles enables an appropriate match for any home. These beads work with any Quick Ship Primed Shaker door to offer a unique look.

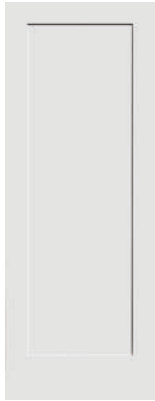

8401



8402



8403



8433



8444



8405



## Beading & Shaker Configurations



Standard  
Shaker Profile



Option  
2-Step Shaker Bead



Option  
Ovolo Bead



Option  
Angle Bead



Option  
Quirk Bead†

†: Quirk can be reversed to be square step bead.

\*Quick Ship: We make every effort to ensure all Quick Ship Items are in stock. However, we do not guarantee stock.

# QUICK SHIP PLANTATION LOUVER | Primed



The Primed Plantation Louver door is not your traditional louver door. Our oversized 3-1/4" louver slat increases ventilation and promotes airflow between rooms while providing the strength and stability of true stile and rail construction.

Our plantation louver door allows for increased privacy while maintaining all of the conventional benefits of a venting louver door.



Custom sizes also available. Contact your dealer for information.

## Louver Door

6/8  
1-3/8"

Quick Ship\* Sizes:  
1/6, 2/0, 2/2,  
2/4, 2/6, 2/8,  
2/10, 3/0 & 3/6

7/0  
1-3/8"

Quick Ship\* Sizes:  
3/0\*

\*7/0 door comes with 10" bottom rail.



8730

## Louver Bi-Folds (includes track & hardware)

6/7  
1-3/8"

Quick Ship\* Sizes:  
2/0, 2/6, 3/0



8730BF

\*Quick Ship: We make every effort to ensure all Quick Ship Items are in stock. However, we do not guarantee stock.

# QUICK SHIP RUSTIC AND SHAKER BARN DOORS



3'6" x 7'0" Knotty Alder 8402BK with 6-1/2" Matte Black Handle and Rustic Track

## Rustic Barn Doors



8401B Knotty Alder



8401BFWR Primed



8402BK Primed



8401BZ Primed



8401BZ Fir



8401BZ Knotty Alder

|                        | 3'0" x 7'0" | 3'6" x 7'0" | 4'0" x 7'0" | 3'6" x 8'0" | 4'0" x 8'0" |
|------------------------|-------------|-------------|-------------|-------------|-------------|
| 8401 BZ Fir            | NA          | ■           | ■           | ■           | ■           |
| 8401 BZ Knotty Alder   | NA          | ■           | ■           | ■           | ■           |
| 8401 BZ Primed         | ■           | ■           | ■           | ■           | ■           |
| 8401 B Knotty Alder    | NA          | ■           | ■           | NA          | NA          |
| 8401 B Primed          | NA          | ■           | ■           | NA          | NA          |
| 8401 BFWR Knotty Alder | NA          | ■           | NA          | NA          | NA          |
| 8401 BFWR Primed       | NA          | ■           | NA          | NA          | NA          |
| 8402 BK Knotty Alder   | NA          | ■           | NA          | NA          | NA          |
| 8402 BK Primed         | NA          | ■           | NA          | NA          | NA          |

Trimlite™ offers a wide selection of Rustic and Shaker style barn doors in both standard and oversized doors. Our barn doors arrive with a routed groove to complement our barn door track. Select yours today.

|      | 2'6" x 7'0" | 2'8" x 7'0" | 3'0" x 7'0" | 2'6" x 8'0" | 2'8" x 8'0" | 3'0" x 8'0" |
|------|-------------|-------------|-------------|-------------|-------------|-------------|
| 8401 | ■           | ■           | ■           | ■           | ■           | ■           |
| 8402 | ■           | ■           | ■           | ■           | ■           | ■           |
| 8433 | ■           | ■           | ■           | ■           | ■           | ■           |
| 8405 | ■           | ■           | ■           | ■           | ■           | ■           |

## Shaker Panel Doors

### Primed



8401



8402



8433



8405

# QUICK SHIP BARN DOOR HARDWARE

Trimlite™ offers several barn door and hardware options in matte black and brushed stainless steel. There are two styles of barn door track, rustic and contemporary. Our rustic track comes with a bent strap hanger. Trimlite™ also offers a contemporary track with a top mount roller. Our hardware is tested to handle doors up to 225 pounds and comes in two sizes, 84" and 96". Select your track and pair it with the perfect barn door handle and pull.

## Rustic Track + Hardware



Matte Black



Brushed Stainless Steel

## Contemporary Track + Hardware



Matte Black



Brushed Stainless Steel



3'0" x 7'0" Knotty Alder 8401BZ  
with Matte Black Hardware  
and 6-1/2" Handle



Contemporary Bar Pulls

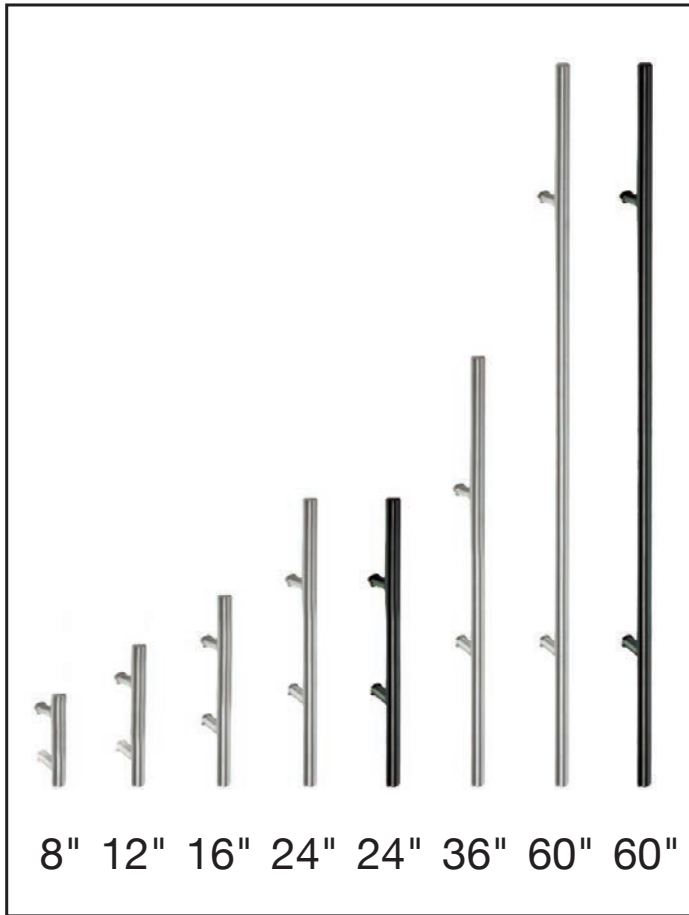

Contemporary pull sizes 8", 12", 16", 24", 36", 60" in stainless steel.

Matte black available in 24" or 60" pull.

Bypass Bracket



Matte Black



Stainless Steel

Rectangular Flush Pulls



Matte Black  
6 1/2"



Brushed Stainless Steel  
6 1/2"

Handles



Matte Black  
6 1/2"



Brushed Stainless Steel  
6 1/2"

Soft Close Hardware

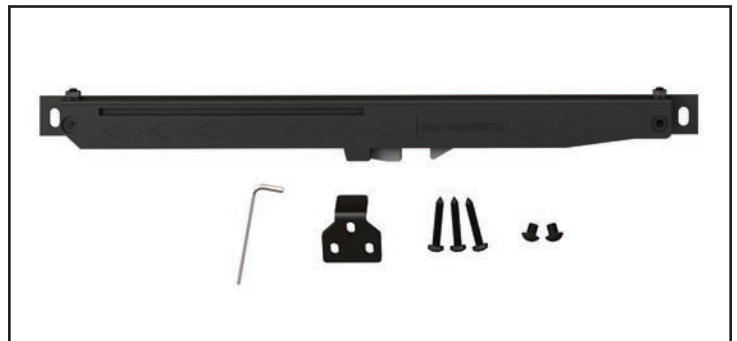

Matte Black



Matte Grey  
(Matches Stainless Steel Track)

## French Doors

Trimlite™ offers a deep and versatile selection of French Door styles and glass designs to complement any architectural style. We offer three door species, Primed, Fir, and Knotty Alder, to match the other doors in your home. There are two French Door styles available—the 1501, which has the traditional ovolo French Door bead, or the 8601\*, which comes with a contemporary quirk bead. We offer a wide variety of decorative glass options, sure to complement any decor.

### Choosing Your Door? Easy as 1, 2, 3

#### 1. Choose Your Door Species:

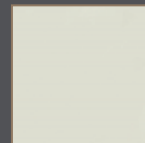

Primed

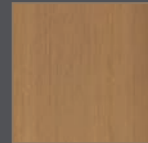

Fir

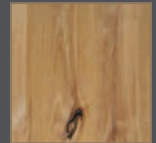

Knotty Alder

#### 2. Choose Your Door Style



1501  
Ovolo Bead



8601\*  
Quirk Bead

#### 3. Choose Your Glass:

See options on pages 19-25.

\*8601 Available in Primed ONLY for Quick Ship. Knotty Alder and Fir available special order.

3'0" x 6'8" 1501 Primed French Door with Rooftop glass



5'0" x 6'8" 3501 Fir French Double Door with Adelaide glass

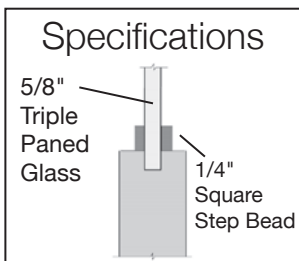

**Available Species**



Available in Patina only

PRIVACY 8

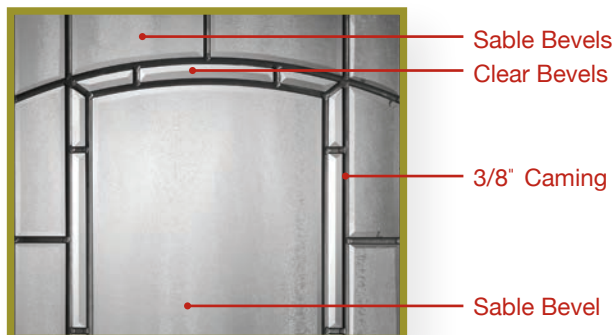

**Adelaide**



6/8



7/0\*







8/0

\*Knotty Alder not available in 7/0.

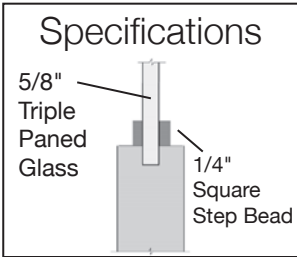

3'0" x 6'8" 3501 Primed French Door with Artisan glass



- Available Species**
-  Primed
  -  Fir
  -  Knotty Alder
- Available in Patina only  
PRIVACY 7

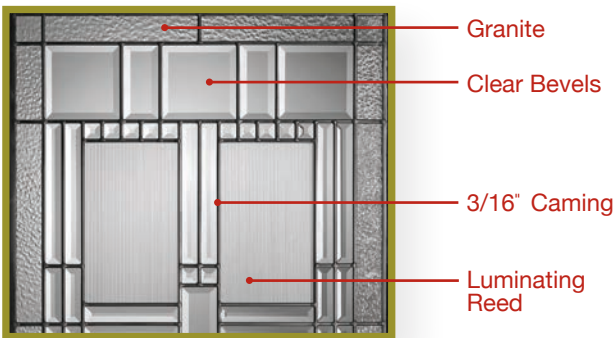

Artisan

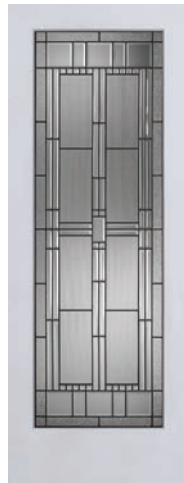

6/8



7/0\*



8/0

\*Knotty Alder not available in 7/0.



2'8" x 6'8" 3501 Primed French Door with Harlow glass

**Specifications**

5/8" Triple Paned Glass  
1/4" Square Step Bead

**Available Species**

Primed    Fir    Knotty Alder

Available in Patina only  
PRIVACY 8

- Narrow Reed
- Granite
- 3/16" Caming
- 3/8" Caming
- Sandblast
- Clear Bevels

Harlow



6/8



7/0\*



8/0

\*Knotty Alder not available in 7/0.

QUICK SHIP DECORATIVE FRENCH DOORS | Lexington



5'0" x 6'8" 3501 Primed French Double Door with Lexington glass

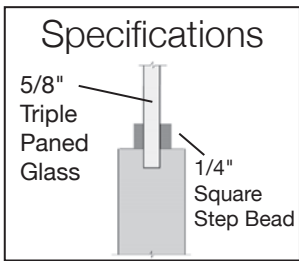

- Available Species**
-  Primed
  -  Fir
  -  Knotty Alder
- Available in Patina only  
PRIVACY 5

Lexington



6/8



7/0\*



8/0

\*Knotty Alder not available in 7/0.

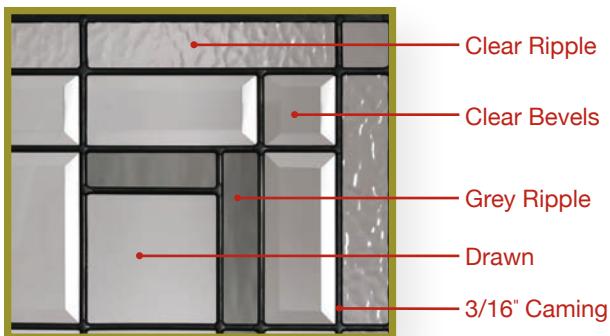



3'0" x 6'8" 3501 Fir French Door with Modena glass

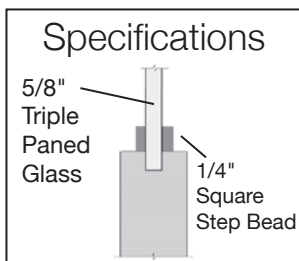

Available in Patina and Zinc (Shown in Zinc) **PRIVACY 7**

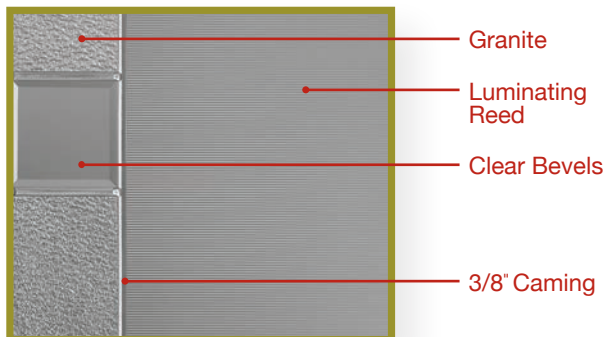

**Modena**



6/8



7/0\*



8/0

\*Knotty Alder not available in 7/0.

# QUICK SHIP RETRO FRENCH DOORS



Clear †\*  
Option: Bevel  
PRIVACY 1



Diffused White  
Laminate †\*  
PRIVACY 10



Satin Etch †\*  
PRIVACY 9



Mirror 2-sided\*  
Option: Mirror  
1-side  
PRIVACY 10



Rain †\*  
PRIVACY 9



Pantry †\*  
PRIVACY 8



Laundry †  
PRIVACY 8



Narrow Reed †\*  
PRIVACY 8



P516 †\*  
PRIVACY 9



Rooftop †\*  
PRIVACY 8

† Tempered Safety Glass  
‡ Laminated Safety Glass

Note: Also available in 7/0 & 8/0\*  
\*Available in full lite (no bottom panel)



# QUICK SHIP RETRO FRENCH DOORS



Quattro †\*  
PRIVACY 7



Screen Dot †\*  
PRIVACY 8



Sable †\*  
PRIVACY 9



Seedy Baroque †\*  
PRIVACY 3



Wheat †  
PRIVACY 7



Madison Castlite †  
PRIVACY 8



Delta Frost †\*  
PRIVACY 9



Riverton Clear †  
PRIVACY 1



Riverton Obscure †  
PRIVACY 8



Kasumi/Travertine †\*  
PRIVACY 8

† Tempered Safety Glass

Note: Also available in 7/0 & 8/0\*

\*Available in full lite (no bottom panel)

# CUSTOM DOORS INTRODUCTION

## LOCAL PRODUCTS

We source our wood products locally, selecting from high grades of Douglas Fir, Knotty Alder, and Pine. Each door represents the Pacific Northwest's best asset, our forests.

## MADE IN CANADA

Our custom doors are all proudly made in Canada. We operate the largest interior door manufacturing location in British Columbia and are proud of our heritage in British Columbia.

## DETAILS MATTER

We pride ourselves on being manufacturers, and to us, details matter. Whether it is a perfect joint, a seam-free door, or a shaker with perfect edges, we want to build the best door every time. Although it might take a little longer than our Quick Ship doors, we want to make sure each handmade door is right the first time.



29" x 6'10" Primed 8402



Trimlite's made in Canada custom shaker doors are factory primed for your convenience.

With many different styles to choose from, our custom primed doors will be the right fit for any project.

Custom options include 1-3/8" and 1-3/4" thicknesses, up to 6'0" x 10'0" door sizes.

 Available as 20-Minute Fire Door.  
Call for sizes and availability.

## Shaker Panel Doors



8401

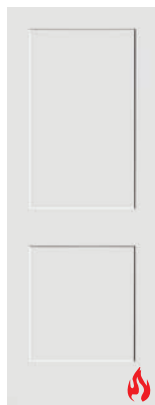

8402



8403



8433



8444



8405

## Shaker Bi-Folds (includes track & hardware)



8401BF



8402BF



8403BF



8433BF



8444BF



8405BF



27" x 67" Primed 8405  
Shaker DWL Door Glass

Trimlite's custom glass Shaker doors are perfect accents for any interior. These doors perfectly complement any shaker door.

Custom options include 1-3/8" and 1-3/4" thicknesses, custom heights, custom widths and custom glass.

### Glass Options\*



Clear  
PRIVACY 1



Seedy Baroque  
PRIVACY 3



Sea Spray  
PRIVACY 5

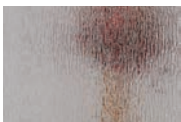

Rain  
PRIVACY 9



Rooftop  
PRIVACY 8



Sable  
PRIVACY 9

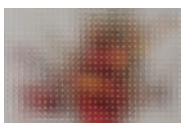

Screen Dot  
PRIVACY 9



Diffused White Laminate  
PRIVACY 10

### Shaker Doors with Glass



8401



8402



8433



8444



8405

### Shaker Bi-Folds with Glass (includes track & hardware)



8401BF



8402BF



8433BF



8444BF



8405BF

\*Other glass options available. Contact your dealer for other designs.

# CUSTOM CONTEMPORARY DOORS WITH PANELS | **Primed**



2'6" x 6'8" Primed 8466 Contemporary Door

Our contemporary collection offers ultra modern styling with sleek lines.

Available options include 1-3/8" and 1-3/4" door thicknesses, 6/8, 7/0, 7/6 and 8/0 heights in all standard widths, and bifolds.

Custom sizes also available. Contact your dealer for information.

## 8400 Shaker Series 6/8 1-3/8"



## 8900 Shaker Series 6/8 1-3/8"





Glass Options\*



Clear  
PRIVACY 1



Seedy Baroque  
PRIVACY 3



Sea Spray  
PRIVACY 5



Rain  
PRIVACY 9



Rooftop  
PRIVACY 8



Sable  
PRIVACY 9

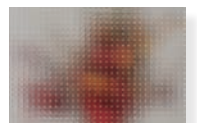

Screen Dot  
PRIVACY 9



Diffused White Laminate  
PRIVACY 10

8400 Shaker Series 6/8 1-3/8"

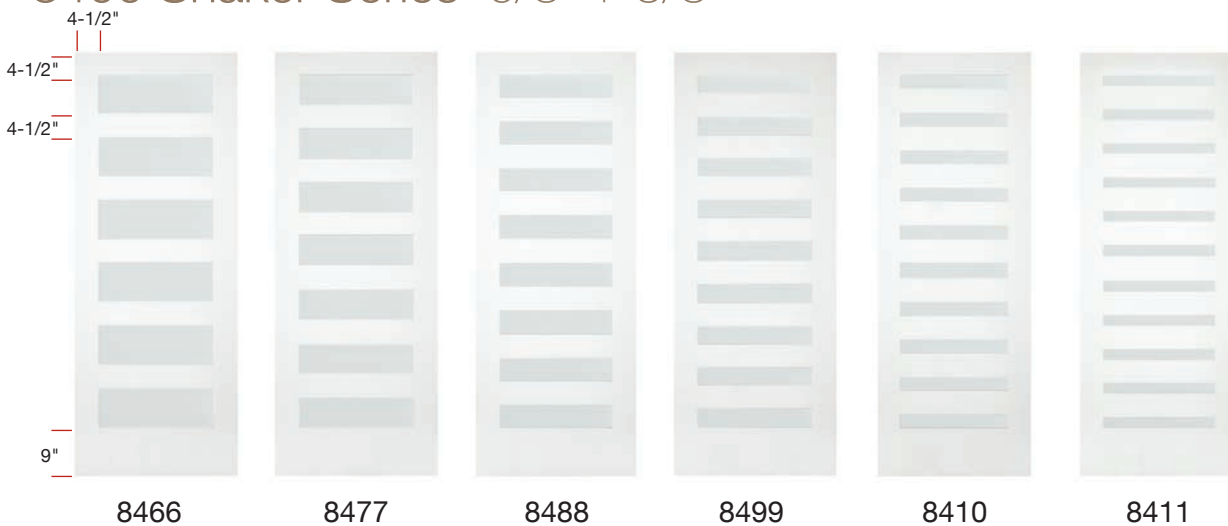

Our contemporary collection offers ultra modern styling with sleek lines. Available with seven different glass options.

Available options include 1-3/8" and 1-3/4" door thicknesses, 6/8, 7/0, 7/6 and 8/0 heights in all standard widths, and bifolds. Custom sizes also available. Contact your dealer for information.

8900 Shaker Series 6/8 1-3/8"

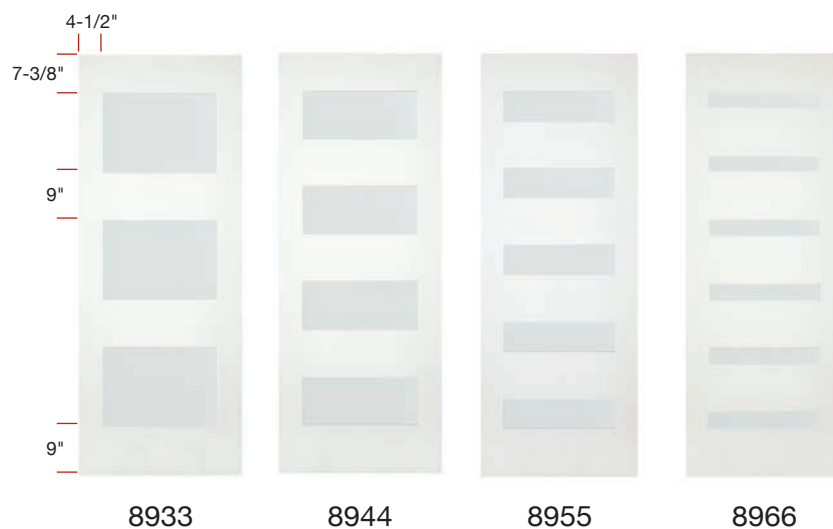

\*Other glass options available. Contact your dealer for other designs.



We use Vertical Grain Douglas Fir, the highest quality fir available. Douglas Fir is timeless, and is used in many architectural styles, from traditional to contemporary. Available options in 1-3/8" and 1-3/4" thicknesses, 6/8, 7/0, and 8/0 heights.

 Available as 20-Minute Fire Door. Call for sizes and availability.

### Shaker Panel Doors



8401



8402



8403



8433



8444



8405

### Shaker Bi-Folds (includes track & hardware)



8401BF



8402BF



8403BF



8433BF



8444BF



8405BF

The materials contained in this page are for presentation purpose; actual unfinished door color may vary.



24" x 6'8" Fir 8499  
Contemporary with Panels

8400 Shaker Series 6/8 1-3/8"



Our contemporary collection offers ultra modern styling with sleek lines.

Available options include 1-3/8" and 1-3/4" door thicknesses, 6/8, 7/0, 7/6 and 8/0 heights in all standard widths, and bifolds. Custom sizes also available. Contact your dealer for information.

8900 Shaker Series 6/8 1-3/8"





### 8400 Shaker Series

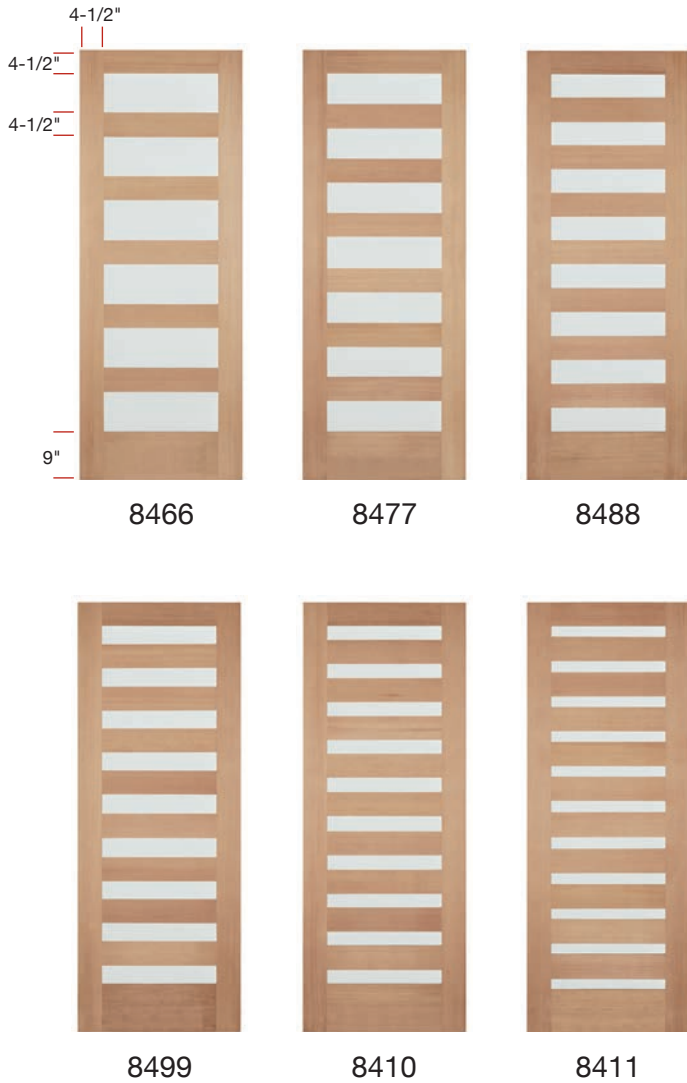

### Glass Options\*



Clear  
PRIVACY 1



Seedy Baroque  
PRIVACY 3



Sea Spray  
PRIVACY 5



Rain  
PRIVACY 9



Rooftop  
PRIVACY 8



Sable  
PRIVACY 9

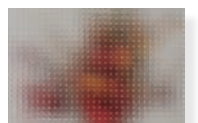

Screen Dot  
PRIVACY 9



Diffused White Laminate  
PRIVACY 10

Our contemporary collection offers ultra modern styling with sleek lines. Available with seven different glass options.

Available options include 1-3/8" and 1-3/4" door thicknesses, 6/8, 7/0, 7/6 and 8/0 heights in all standard widths, and bifolds. Custom sizes also available. Contact your dealer for information.

### 8900 Shaker Series



\*Other glass options available. Contact your dealer for other designs.

# CUSTOM SHAKER DOORS & BIFOLDS | Knotty Alder



2'9" x 6'8" Knotty Alder  
8402 Shaker Door

Our Knotty Alder doors provide a rustic look for homeowners and are popular in a variety of modern and traditional homes.

Available options include 1-3/8" and 1-3/4" door thicknesses, 6/8, 7/0, 7/6 and 8/0 heights in all standard widths, and bifolds.

 Available as 20-Minute Fire Door.  
Call for sizes and availability.

## Shaker Panel Doors 6/8 1-3/8"



8401



8402



8403



8433



8444



8405

## Shaker Bi-Folds 6/8 1-3/8" (includes track & hardware)



8401BF



8402BF



8403BF



8433BF



8444BF



8405BF

# CUSTOM OVERSIZED SHAKER BARN DOORS

## Shaker Panel Doors



Primed



Fir

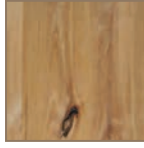

Knotty Alder



8401



8402



8403



8433



8444



8405



3'0" x 7'0" Primed 8433 with Contemporary Matte Black Hardware and 6-1/2" Flush Pull

## Shaker French Doors

### Primed Diffused White Laminate (DWL)

|             | Primed | Fir | Knotty Alder | Primed DWL |
|-------------|--------|-----|--------------|------------|
| 3'0" x 7'0" | ■      | ■   | ■            | ■          |
| 3'6" x 7'0" | ■      | ■   | ■            | ■          |
| 4'0" x 7'0" | ■      | ■   | ■            | ■          |
| 5'0" x 7'0" | ■      | ■   | NA           | ■          |
| 3'0" x 8'0" | ■      | ■   | ■            | ■          |
| 3'6" x 8'0" | ■      | ■   | ■            | ■          |
| 4'0" x 8'0" | ■      | ■   | ■            | ■          |
| 5'0" x 8'0" | ■      | NA  | NA           | ■          |



8401



8433



8444



8405

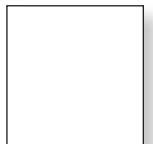

White Laminate

PRIVACY 10

Any DWL Barn Doors over 3'0" in width will use tempered DWL glass.  
Any doors over 3'6" in width will use 5-1/2" top rail and stiles.

# CUSTOM CONTEMPORARY BARN DOORS WITH GLASS

## Contemporary Doors



Primed



Fir



8933



8944



8955



8466



8477



8488



8499



8410



8411

|             | Primed | Fir |
|-------------|--------|-----|
| 3'0" x 7'0" | ■      | ■   |
| 3'6" x 7'0" | ■      | ■   |
| 3'0" x 8'0" | ■      | ■   |
| 3'6" x 8'0" | ■      | ■   |



3'6" x 7'0" 8955 Primed Contemporary Door with DWL Glass, Contemporary Stainless Steel Hardware and 24" Contemporary Bar Pull

Any DWL Barn Doors over 3'0" in width will use tempered DWL glass.



2'8" x 6'8" Primed  
1433 Ovolo Door

## Flat Panel Ovolo Bead Doors

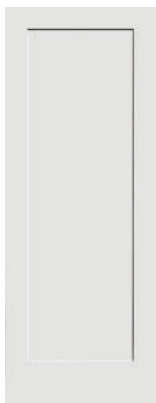

1401



1402



1403



1433



1444



1405

## Specifications

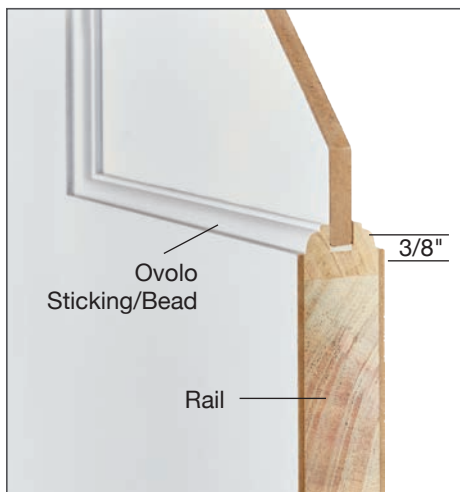

We added a decorative Ovolo Bead to our Flat Panel Doors to create our 1400 Series. This bead is manufactured with precision, no nail holes, and consistent reveals at every edge.

Available in a variety of panel layouts and wood species.

Available in 1-3/8" and 1-3/4" door thicknesses and 6/8, 7/0, 7/6 and 8/0 heights in all standard widths, and bifolds. Custom sizes also available.

# CUSTOM RAISED PANEL DOORS | Primed



Our Raised Panel doors are a timeless look. We offer three different panel layouts (Double Hip, Single Hip, and Scoop) for any traditional style.

Available options include 1-3/8" and 1-3/4" door thicknesses, 6/8, 7/0, 7/6 and 8/0 heights in all standard widths, and bifolds. Custom sizes also available.

## Specifications

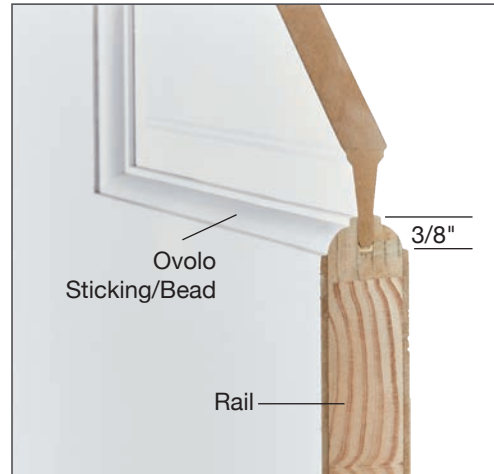

## Raised Panel Doors



OV11



OV22



OV24



OV33



OV44



OV55



OV66



26" x 68" Primed  
8403 HD Shaker

The High Definition Shaker Door combines the sharp edges and clean lines of traditional shaker doors with a contemporary twist. True 90-degree angles where the panel meets the solid wood stiles and rails give this door a clean look. 20-Minute Fire Rated doors now available.

### Specifications

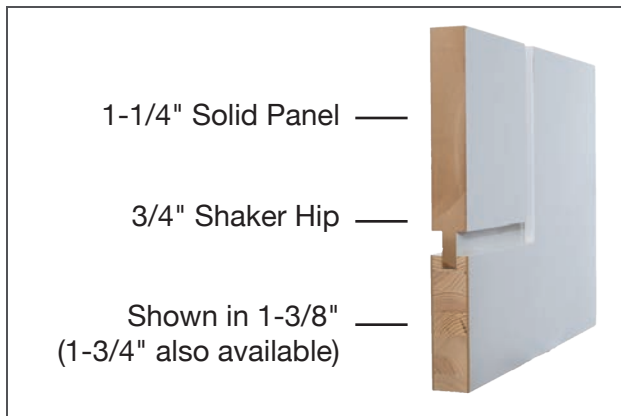

 Available as 20-Minute Fire Door.  
Call for sizes and availability.

### High Definition Doors



8401HD



8402HD



8403HD



8433HD



8444HD



8405HD



26" x 68" Primed  
8402 HD Shaker

# CUSTOM WOODBAR FRENCH DOORS | Primed

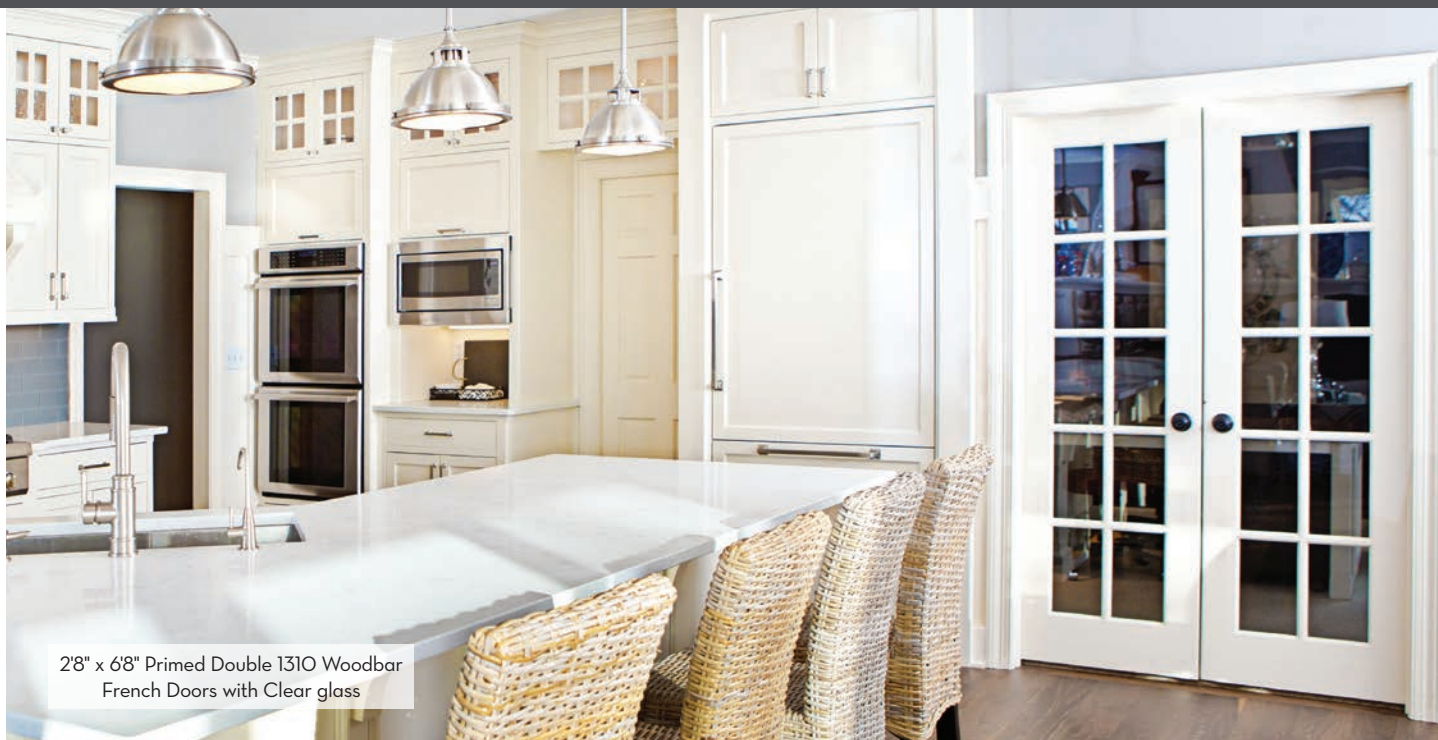

Our Woodbar Doors provide a unique look for your home – a door with true divided lites. This gives a distinct aesthetic and will stand out in any setting.

## Lite Options



1310



1315



1304



1305



1306



1309\*

## Mullion Configurations

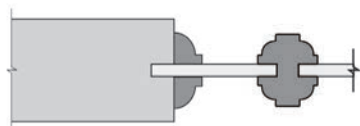

TDL Ovolo Bead

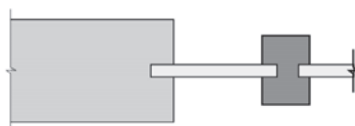

TDL Shaker Bead





Available in 1-3/8" and 1-3/4" thicknesses, and 6/8, 7/0, or 8/0 heights.

## Glass Options



Clear/Bevel  
PRIVACY 1



Seedy Baroque  
PRIVACY 3



Sea Spray  
PRIVACY 5



Rain  
PRIVACY 9



Rooftop  
PRIVACY 8



Sable  
PRIVACY 9

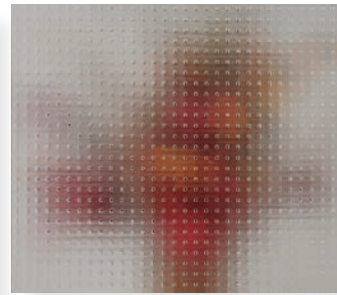

Screen Dot  
PRIVACY 9

# INTERIOR DOOR COMPONENTS

## 3-1/2", 1/4" Radius Hinge Colors



Brass  
US3



Oil Rubbed Bronze  
US10B



Satin Nickel  
US15



Black  
US1D



Brushed Chrome  
US26D

## Jambs & Astragals



Primed Finger-Joint Double  
Rabbet Jamb (4-9/16")



Primed Finger-Joint  
Combo Jamb (4-9/16")



Primed Finger-Joint Astragal



Hemlock Double Rabbet  
Jamb (4-9/16")



Hemlock Combo Jamb  
(4-9/16" - 7-1/4")



Hemlock Astragal

(VG Fir and Knotty Alder jambs are special order and available with extended leadtime.)

## Flush Bolts

6" Flush Bolts  
(Standard on 6-8 & 7-0 Doors)



Satin Nickel US15  
(Also Available in Brass US3 &  
Oil Rubbed Bronze US10B)

12" Flush Bolts  
(Standard on 8-0 Doors)



Brass  
US3

Oil-Rubbed  
Bronze  
US10B

Satin  
Nickel  
US15

## Bypass Rollers & Track



Heavy-duty aluminum box track and three-wheeled ball bearing rollers hold doors weighing up to 150 lbs. each.

## Roller Catch & Strike



Oil Rubbed  
Bronze US10B  
(Also Available in  
Satin Nickel US15)

## Ball Catch & Strike



Brass US3  
(Also Available  
in Oil-Rubbed  
Bronze US10B & Satin Nickel US15)

# 20-MINUTE DOOR HANGING OPTIONS

## 4", 1/4" Radius Hinge Colors



Brass  
US3



Oil Rubbed Bronze  
US10B



Satin Nickel  
US15



Black  
US1D



Brushed Chrome  
US26D

All 20-Minute doors come with 2-spring hinges (not shown)

## Sill Options

### Inswing Fixed Sill

- Thermal Efficient Composite Cap
- Durable Economic Design
- Water-Tight Butyl End Seal Gasket



### Inswing Adjustable Sill

- High Performance Seal Technology
- All Composite for Durability
- Adjustable Rail Ensuring a Tight Fit
- Water-Tight Butyl End Seal Gasket



### Outswing Bumper Sill

- All-Aluminum Durability
- High Performance Outswing Design
- Water-Tight Butyl End Seal Gasket

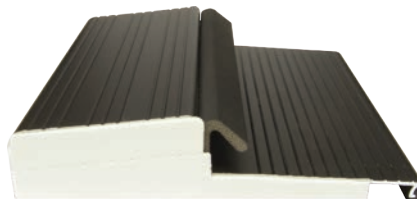

### Outswing Oak Bumper Sill

- Stain Grade Hardwood Interior
- High Performance Outswing Design
- Water-Tight Butyl End Seal Gasket



### LowPro Sill (Inswing or Outswing)

- ADA Compliant
- Durable All-Aluminum Design
- Not Recommended for High Water Exposure

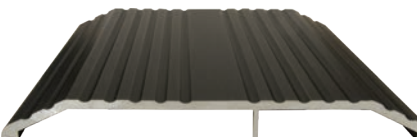

## Sill Finishes



Mill Finish



Bronze Finish

## Jamb

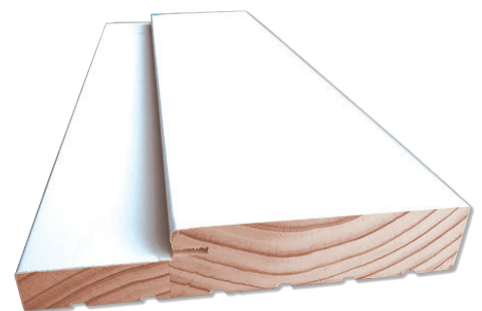

Primed Single Rabbet Jamb  
(4-9/16", 6-9/16", 7-1/4")

# QUICK SHIP STOCKING SIZES

Due to ongoing product development we reserve the right to make changes in design, materials and specifications without notice.

## LEGEND

N/A = NOT AVAILABLE + = SPECIAL ORDER ■ = IN STOCK E = EXTENDED LEADTIME

| DESCRIPTIONS                                            | DOOR WIDTHS                      |     |      |             |     |     |             |      |      |             | DOOR HEIGHTS |         |             | Bi-Fold |         | 20 MIN. | Door Thickness |
|---------------------------------------------------------|----------------------------------|-----|------|-------------|-----|-----|-------------|------|------|-------------|--------------|---------|-------------|---------|---------|---------|----------------|
|                                                         | 1/6                              | 1/8 | 1/10 | 2/0         | 2/2 | 2/4 | 2/6         | 2/8  | 2/10 | 3/0         | 6/8          | 7/0     | 8/0         | Bi-Fold | DWL     |         |                |
| <b>Pages 10-11 Primed Shaker Doors &amp; Bi-Folds</b>   |                                  |     |      |             |     |     |             |      |      |             |              |         |             |         |         | 20 MIN. | 1-3/4"         |
| 8401 1-3/8"                                             | ■                                | ■   | ■    | ■           | ■   | ■   | ■           | ■    | ■    | ■           | ■            | ■       | ■           | ■       | ■       | ■       | +              |
| 8402 1-3/8"                                             | ■                                | ■   | ■    | ■           | ■   | ■   | ■           | ■    | ■    | ■           | ■            | ■       | ■           | ■       | +       | ■       | +              |
| 8403 1-3/8"                                             | ■                                | ■   | ■    | ■           | ■   | ■   | ■           | ■    | ■    | ■           | ■            | +       | ■           | ■       | +       | ■       | +              |
| 8433 1-3/8"                                             | ■                                | ■   | ■    | ■           | ■   | ■   | ■           | ■    | ■    | ■           | ■            | ■       | ■           | ■       | ■       | ■       | +              |
| 8444 1-3/8"                                             | ■                                | ■   | ■    | ■           | ■   | ■   | ■           | ■    | ■    | ■           | ■            | +       | +           | +       | +       | ■       | +              |
| 8405 1-3/8"                                             | ■                                | ■   | ■    | ■           | ■   | ■   | ■           | ■    | ■    | ■           | ■            | ■       | ■           | ■       | ■       | ■       | +              |
| 8491 1-3/8"                                             | ■                                | N/A | N/A  | ■           | ■   | ■   | ■           | ■    | ■    | ■           | ■            | +       | ■           | ■       | N/A     | ■       | +              |
| <b>Page 11 Flat Panel Ovolo Doors &amp; Bi-Folds</b>    | 1/6                              |     | 2/0  | 2/2         | 2/4 | 2/6 | 2/8         | 2/10 | 3/0  | 6/8         | 7/0          | 8/0     | Bi-Fold     |         | 20 MIN. | 1-3/4"  |                |
| 8020 1-3/8"                                             | ■                                | ■   | ■    | ■           | ■   | ■   | ■           | ■    | ■    | ■           | +            | +       | ■           |         | ■       | +       |                |
| 8082 1-3/8"                                             | ■                                | ■   | ■    | ■           | ■   | ■   | ■           | ■    | ■    | ■           | +            | +       | ■           |         | ■       | +       |                |
| <b>Page 11 Woodbar Doors</b>                            | 1/6                              | 2/0 | 2/2  | 2/4         | 2/6 | 2/8 | 2/10        | 3/0  | 6/8  | 7/0         | 8/0          | Bi-Fold |             | 20 MIN. | 1-3/4"  |         |                |
| 1309 1-3/8"                                             | +                                | +   | +    | ■           | ■   | ■   | N/A         | ■    | ■    | +           | +            | N/A     |             | N/A     | +       |         |                |
| 1310 1-3/8"                                             | +                                | ■   | ■    | ■           | ■   | ■   | N/A         | ■    | ■    | +           | +            | N/A     |             | N/A     | +       |         |                |
| <b>Page 12 Knotty Alder Shaker Doors &amp; Bi-Folds</b> | 1/6                              | 2/0 | 2/2  | 2/4         | 2/6 | 2/8 | 2/10        | 3/0  | 6/8  | 7/0         | 8/0          | Bi-Fold |             | 20 MIN. | 1-3/4"  |         |                |
| Knotty Alder 8401 1-3/8"                                | ■                                | ■   | ■    | ■           | ■   | ■   | ■           | ■    | ■    | +           | +            | ■       |             | +       | +       |         |                |
| Knotty Alder 8402 1-3/8"                                | ■                                | ■   | ■    | ■           | ■   | ■   | ■           | ■    | ■    | +           | +            | ■       |             | +       | +       |         |                |
| Knotty Alder 8403 1-3/8"                                | ■                                | ■   | ■    | ■           | ■   | ■   | ■           | ■    | ■    | +           | +            | ■       |             | +       | +       |         |                |
| <b>Page 12 Fir Shaker Doors &amp; Bi-Folds</b>          | 1/6                              | 2/0 | 2/2  | 2/4         | 2/6 | 2/8 | 2/10        | 3/0  | 6/8  | 7/0         | 8/0          | Bi-Fold |             | 20 MIN. | 1-3/4"  |         |                |
| Fir 8401 1-3/8"                                         | ■                                | ■   | ■    | ■           | ■   | ■   | ■           | ■    | ■    | +           | +            | ■       |             | +       | +       |         |                |
| Fir 8402 1-3/8"                                         | ■                                | ■   | ■    | ■           | ■   | ■   | ■           | ■    | ■    | +           | +            | ■       |             | +       | +       |         |                |
| Fir 8403 1-3/8"                                         | ■                                | ■   | +    | ■           | ■   | ■   | ■           | ■    | ■    | +           | +            | ■       |             | +       | +       |         |                |
| Fir 8433 1-3/8"                                         | ■                                | ■   | +    | ■           | ■   | ■   | ■           | ■    | ■    | +           | +            | ■       |             | +       | +       |         |                |
| Fir 8405 1-3/8"                                         | ■                                | ■   | +    | ■           | ■   | ■   | ■           | ■    | ■    | +           | +            | ■       |             | +       | +       |         |                |
| <b>Page 14 Primed Plantation Louver</b>                 | 1/6                              | 2/0 | 2/2  | 2/4         | 2/6 | 2/8 | 2/10        | 3/0  | 6/8  | 7/0         | 8/0          | Bi-Fold |             | 20 MIN. | 1-3/4"  |         |                |
| Primed Plantation Louver Door 1-3/8"                    | ■                                | ■   | ■    | ■           | ■   | ■   | ■           | ■    | ■    | ■           | N/A          | ■       |             | N/A     | N/A     |         |                |
| <b>DESCRIPTIONS</b>                                     | <b>DOOR WIDTHS &amp; HEIGHTS</b> |     |      |             |     |     |             |      |      |             |              |         |             |         |         |         |                |
| <b>Page 15 Rustic and Shaker Barn Doors</b>             | 3'0" x 7'0"                      |     |      | 3'6" x 7'0" |     |     | 4'0" x 7'0" |      |      | 3'6" x 8'0" |              |         | 4'0" x 8'0" |         |         |         |                |
| 8401B Primed 1-3/8"                                     | N/A                              |     |      | ■           |     |     | ■           |      |      | N/A         |              |         | N/A         |         |         |         |                |
| 8401B Knotty Alder 1-3/8"                               | N/A                              |     |      | ■           |     |     | ■           |      |      | N/A         |              |         | N/A         |         |         |         |                |
| 8401BFWR Primed                                         | N/A                              |     |      | ■           |     |     | N/A         |      |      | N/A         |              |         | N/A         |         |         |         |                |
| 8401BFWR Knotty Alder                                   | N/A                              |     |      | ■           |     |     | N/A         |      |      | N/A         |              |         | N/A         |         |         |         |                |
| 8401BZ Primed                                           | ■                                |     |      | ■           |     |     | ■           |      |      | ■           |              |         | ■           |         |         |         |                |
| 8401BZ Knotty Alder                                     | N/A                              |     |      | ■           |     |     | ■           |      |      | ■           |              |         | ■           |         |         |         |                |
| 8401BZ Fir                                              | N/A                              |     |      | ■           |     |     | ■           |      |      | ■           |              |         | ■           |         |         |         |                |
| 8402BK Primed                                           | N/A                              |     |      | ■           |     |     | N/A         |      |      | N/A         |              |         | N/A         |         |         |         |                |
| 8402BK Knotty Alder                                     | N/A                              |     |      | ■           |     |     | N/A         |      |      | N/A         |              |         | N/A         |         |         |         |                |

# QUICK SHIP STOCKING SIZES

| DESCRIPTIONS                    | DOOR WIDTHS & HEIGHTS |             |             |             |             |             |      |     |              |     |     |                |
|---------------------------------|-----------------------|-------------|-------------|-------------|-------------|-------------|------|-----|--------------|-----|-----|----------------|
| Page 15 Shaker Panel Barn Doors | 2'6" x 7'0"           | 2'8" x 7'0" | 3'0" x 7'0" | 2'6" x 8'0" | 2'8" x 8'0" | 3'0" x 8'0" |      |     |              |     |     |                |
| 8401 Primed Shaker Panel        | ▪                     | ▪           | ▪           | ▪           | ▪           | ▪           |      |     |              |     |     |                |
| 8402 Primed Shaker Panel        | ▪                     | ▪           | ▪           | ▪           | ▪           | ▪           |      |     |              |     |     |                |
| 8433 Primed Shaker Panel        | ▪                     | ▪           | ▪           | ▪           | ▪           | ▪           |      |     |              |     |     |                |
| 8405 Primed Shaker Panel        | ▪                     | ▪           | ▪           | ▪           | ▪           | ▪           |      |     |              |     |     |                |
| DESCRIPTIONS                    | DOOR WIDTHS           |             |             |             |             |             |      |     | DOOR HEIGHTS |     |     |                |
| French Door                     | 1/6                   | 2/0         | 2/2         | 2/4         | 2/6         | 2/8         | 2/10 | 3/0 | 6/8          | 7/0 | 8/0 | 8/0<br>Paneled |
| Adelaide (P)*                   | N/A                   | ▪           | ▪           | ▪           | ▪           | ▪           | ▪    | ▪   | ▪            | ▪   | N/A | ▪              |
| Harlow (P)*                     | N/A                   | ▪           | ▪           | ▪           | ▪           | ▪           | ▪    | ▪   | ▪            | ▪   | N/A | ▪              |
| Artisan (P)*                    | N/A                   | ▪           | ▪           | ▪           | ▪           | ▪           | ▪    | ▪   | ▪            | ▪   | N/A | ▪              |
| Modena (P,Z)*                   | N/A                   | ▪           | ▪           | ▪           | ▪           | ▪           | ▪    | ▪   | ▪            | ▪   | N/A | ▪              |
| Riverton Clear                  | N/A                   | ▪           | ▪           | ▪           | ▪           | ▪           | ▪    | ▪   | ▪            | ▪   | N/A | ▪              |
| Seedy Baroque                   | E                     | E           | E           | E           | E           | E           | E    | E   | E            | E   | E   | E              |
| Wheat                           | N/A                   | ▪           | ▪           | ▪           | ▪           | ▪           | ▪    | ▪   | ▪            | ▪   | N/A | ▪              |
| Quattro                         | E                     | E           | E           | E           | E           | E           | E    | E   | E            | E   | E   | E              |
| Rooftop                         | E                     | E           | E           | E           | E           | E           | E    | E   | E            | E   | E   | E              |
| Kasumi/Travertine               | E                     | E           | E           | E           | E           | E           | E    | E   | E            | E   | E   | E              |
| Sable                           | E                     | E           | E           | E           | E           | E           | E    | E   | E            | E   | E   | E              |
| Screen Dot                      | E                     | E           | E           | E           | E           | E           | E    | E   | E            | E   | E   | E              |
| P516                            | E                     | E           | E           | E           | E           | E           | E    | E   | E            | E   | E   | E              |
| Delta Frost                     | E                     | E           | E           | E           | E           | E           | E    | E   | E            | E   | E   | E              |
| Lexington (P)*                  | N/A                   | ▪           | ▪           | ▪           | ▪           | ▪           | ▪    | ▪   | ▪            | ▪   | N/A | ▪              |
| Rain                            | ▪                     | ▪           | ▪           | ▪           | ▪           | ▪           | ▪    | ▪   | ▪            | ▪   | ▪   | ▪              |
| Madison                         | N/A                   | ▪           | ▪           | ▪           | ▪           | ▪           | ▪    | ▪   | ▪            | ▪   | N/A | ▪              |
| Glue Chip (P,Z)*                | E                     | E           | E           | E           | E           | E           | E    | E   | E            | E   | N/A | E              |
| Narrow Reed                     | ▪                     | ▪           | ▪           | ▪           | ▪           | ▪           | ▪    | ▪   | ▪            | ▪   | ▪   | ▪              |
| Clear                           | ▪                     | ▪           | ▪           | ▪           | ▪           | ▪           | ▪    | ▪   | ▪            | ▪   | ▪   | ▪              |
| Satin Etch                      | ▪                     | ▪           | ▪           | ▪           | ▪           | ▪           | ▪    | ▪   | ▪            | ▪   | ▪   | ▪              |
| Riverton Obscure                | N/A                   | ▪           | ▪           | ▪           | ▪           | ▪           | ▪    | ▪   | ▪            | ▪   | N/A | ▪              |
| Pantry                          | N/A                   | ▪           | ▪           | ▪           | ▪           | ▪           | ▪    | ▪   | ▪            | ▪   | ▪   | ▪              |
| Laundry                         | N/A                   | N/A         | N/A         | N/A         | ▪           | ▪           | ▪    | ▪   | ▪            | ▪   | N/A | ▪              |
| Diffused White Laminate         | ▪                     | ▪           | ▪           | ▪           | ▪           | ▪           | ▪    | ▪   | ▪            | ▪   | ▪   | ▪              |
| Mirror                          | ▪                     | ▪           | ▪           | ▪           | ▪           | ▪           | ▪    | ▪   | ▪            | ▪   | ▪   | ▪              |

Note: French Door sizes for primed only. Contact your sales rep. for custom sizes.



Trimlite warrants, that each door bearing the Trimlite brand and identification mark, is of good material and workmanship and free from defects which renders them unserviceable or unfit for ordinary, recommended use. Trimlite warranty is for a period of ONE YEAR from date of shipment from Trimlite, provided the following conditions are met:

1. Manufacturing defects must be reported promptly before fitting, finishing, or hanging. Failure to do so will result in forfeiture of any warranty.
2. Provided that doors are operative, action on any claims after installation may be deferred at the option of Trimlite for a period not exceeding twelve months from date of complaint. During this time period, doors must remain hung in the original installation to permit conditioning to local humidity and temperature conditions.
3. Trimlite agrees, at our option, to either (1) repair without charge or (2) replace without charge or (3) refund original purchase price, any door that is defective within the meaning of this guarantee. Trimlite is not responsible for any costs associated with installation or finishing of replacement door or door components as well as any incidental or consequential damages, all of which will remain the sole responsibility of person making the warranty claim.
4. In the case of exterior applications, doors must be hung in a location protected from exposure to direct sun or rain under normal conditions. Refer to Care and Finishing Procedure for Wood Doors: Section: Figure 2 Overhang Guide
5. The entire door, including edges, top, bottom, and sides must receive at least two coats of an oil base paint, varnish, or sealer at the time of installation. Refer to Care and Finishing Section. (Failure to follow Trimlite finishing instructions will void any warranty.)
6. Trimlite warranty extends only to the first purchaser or retailer of said door(s) and is not transferable.

### Allowable Tolerances

1. Thickness, width, and height tolerances from nominal sizes shall not exceed 1/16" plus or minus.
2. A squareness tolerance of not more than 1/8" between two diagonal measurements taken across the face of the door shall be allowed.
3. For doors 3' x 7' or smaller, deformation (bow, cup, twist, warp) shall not be considered a defect unless it exceeds 1/4" in the plane of the door itself. Warranty can apply for 1-3/4" doors up to 42" x 96" if properly installed with a three-point locking mechanism.
4. Trimlite will not warranty against warp on any doors exceeding 42" in width or 96" in height.

### Exclusions

The following are not defects in workmanship or material and are not covered by this written warranty:

1. Damage caused by attempts other than Trimlite's to repair the door and/or unit.
2. Failure to properly seal the door. All edges must be sealed within 72 hours after fitting and hanging with the integrity of the finish maintained.
3. Defects caused by improper installation such that the door does not swing freely.
4. Damage cause by improper handling or on-site storage
5. Due to uncontrolled site conditions the appearance of field finished doors is not guaranteed by Trimlite.
6. Natural variations in the color or texture of the wood are not to be considered as defects.
7. Panel shrinkage is not considered a defect and would not be covered by this warranty.
8. Failure to provide normal homeowner maintenance on the door finish.
9. Doors or door components that are not finished and hung in accordance with the Care and Finishing instructions; and doors/ components that are exposed to direct sun or rain under normal conditions.

### Door Policy

1. RECEIVING: Upon receiving, order must be checked for accuracy or damage. If damage is apparent, it must be noted on the delivery receipt. Claims for shipping damage or loss must be filed with the carrier by the customer. While we do our best to protect product for shipping, wood doors are rather fragile and can be easily marked so a thorough inspection by your receiving dept. is necessary. Any damage or shortages must be reported to Trimlite Customer Service within 24 hours of receipt.
2. SPECIAL ORDERS: Care must be taken to insure order accuracy. Order sheets with swing diagrams are available. Special order cancellation will not be accepted once work has begun on the unit.
3. RETURN GOODS AUTHORIZATIONS (RGA) Contact your Trimlite representative to request inspection and return authorization. All doors approved for return must be shipped back to Trimlite in the same condition in which it was shipped. Your Trimlite account manager will specify the method of return. No credit will be given for doors returned in non-saleable condition. Trimlite will refuse any product returned which does not have an RGA number.

### Claim Policy

1. A representative of your firm must inspect the unit.
2. Provide purchase order number, invoice number, and original ship date.
3. Identify product and problem.
4. Provide contact names and phone numbers.
5. With the above information, Trimlite will make arrangements to go to the job site with a representative of your firm.
6. Upon establishing there is a valid warranty situation, Trimlite will repair, replace or refund the original purchase price as per the guarantee.





## Canada

### WEST

#### SURREY, BC

T 604.533.4111

TF 877.533.4111

F 604.533.2026

### EAST

#### BURLINGTON, ON

T 905.335.1559

TF 888.335.1559

F 905.335.6464

[www.trimlite.com](http://www.trimlite.com)

[info@trimlite.com](mailto:info@trimlite.com)

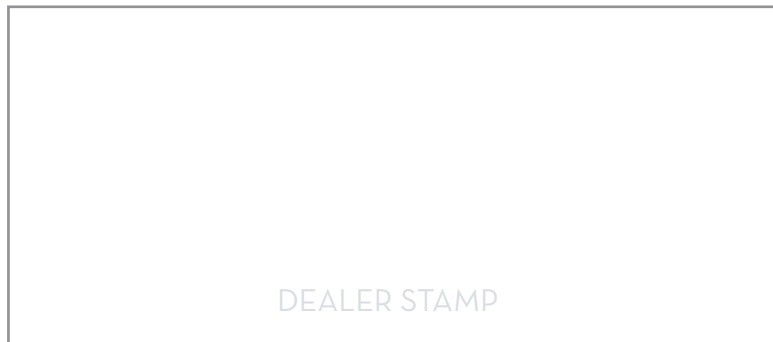

DEALER STAMP

## USA

### WEST

#### RENTON, WA

T 425.251.8685

TF 800.929.3371

F 425.251.8999

### EAST

#### ASHTABULA, OH

TF 800.929.3371

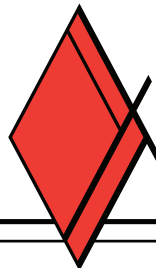

# TRIMLITE